

Article number: 2302065705
 Description: E+G Three-arm knob
 VB.639/100 B-M12

Measures

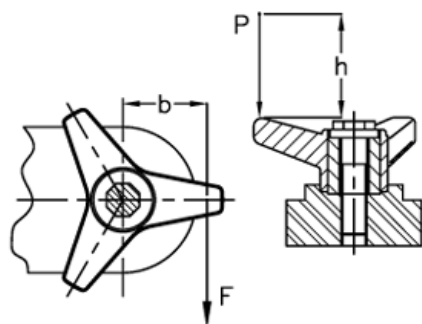
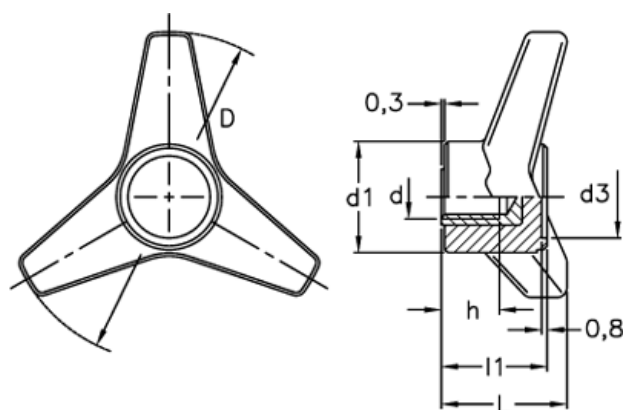

$$C[N \cdot m] = F[N] \cdot b[m] \quad L[J] = P[N] \cdot h[m]$$

C (N m)	= 110	l1 = 36
D	= 100	
d1	= 36	
d3	= 25	
d 6H	= M12	
h	= 20	
L	= 42	
L(J)	= 8	